

Product Description

商品説明

Number 品番	DS-670A-①	Types 種類	Push Switch 押釦スイッチ	Photo 写真 
Circuit 回路	SPDT(3P)	Operation 機能	ON - ON オルタネイト	
Rating 定格	3A.125V.AC 1A.250V.AC	Terminal 端子	See details 詳細参照	
Insulation resistance 絶縁抵抗	DC.500V/100MΩ or more	Voltage breakdown 耐電圧	AC. 1,500V/1min	
Contact resistance 接触抵抗	20mΩ or less	Exterior 外観	See details 詳細参照	

Dimensions 寸法図

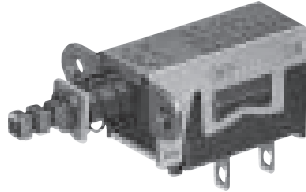
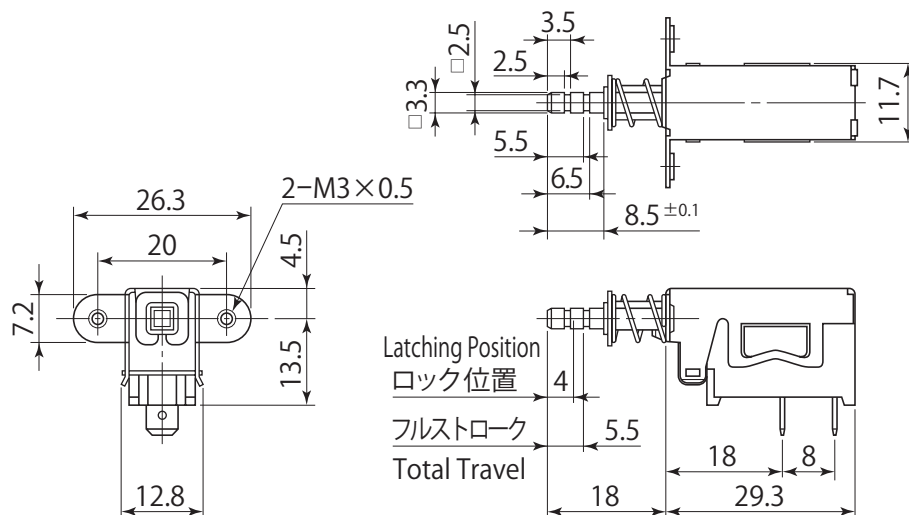

Details 詳細

This switch is a push switch for use inside the device, and the actuator cap is sold separately.
このスイッチは機器内用プッシュスイッチで、操作部キャップは別売です。

There are different types of terminal shapes ① as shown in the table below.
端子の形状①は下表のような種類があります。

① Terminal symbol / 端子記号	Terminal shape / 端子形状
S	Solder Terminal / はんだ端子
F	#187 Faston tabs / ファストン端子
P	PC Terminal / PC端子

The shape and color of the knobs (sold separately) are as shown in the table below.
別売のツマミの形状および色は下表のような種類があります。

Knob Shape / ツマミ形状	Color / 色
C: Circle (丸型)	R: Red K: Black N: Gray (Special order/特注)
E: Ellipse (楕円型)	
S: Square (正角形)	
R: Rectangle (長角形)	