

Product Description

商品説明

Number 品番	DS-152-W2	Types 種類	Slide switch スライドスイッチ	Photo 写真
Circuit 回路	SPST (2P)	Operation 機能	ON - OFF	
Rating 定格	3A.125V.AC 1A.250V.AC	Terminal 端子	Solder Terminal はんだ端子	
Insulation resistance 絶縁抵抗	DC.500V/100MΩ or more	Voltage breakdown 耐電圧	AC.1,500V/1min	
Contact resistance 接触抵抗	20mΩ or less	Exterior 外観	Resin knob 樹脂ツマミ	

Dimensions 寸法図

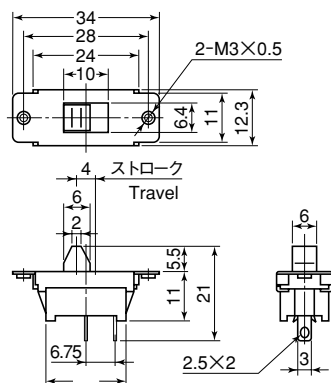

Details 詳細